

ТЕХНИЧЕСКА ХАРАКТЕРИСТИКА

АНКЕР – FBN II - за леки закрепвания, с гайка, поцинкован, с удължена резба

Bolt FBN II

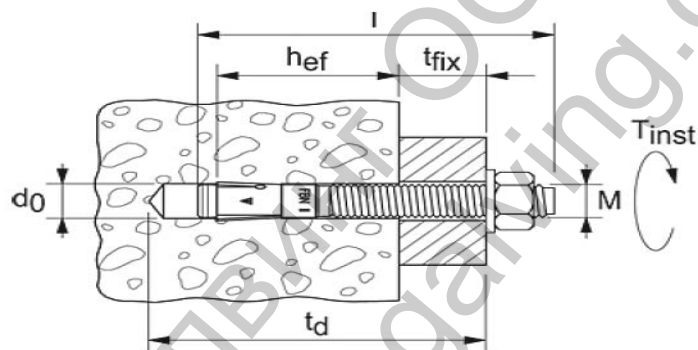







Характеристики: Одобрен за не ронлив бетон от C20/25 до C50/60































Подходящи също за бетон С 12/15, както и натурален камък с гъста, плътна, компактна структура.

За монтаж на : стоманени конструкции, конзоли, стълбища, машини, порти, фасади, дървени конструкции, елементи на прозорци, парпети, перила и др.

Размери - виж. Стр 2

Type	Art.-No.	ETA DIBt	Imprint on head	drill d ₀ [mm]	max. usable length t _{fix} [mm]	anchorage depth h _{ef} [mm]	min. drill-hole depth for through fixings t _d [mm]	anchor length l [mm]	thread [Ø x length]	qty. per box pcs.
FBN II 8/5 (8x66)	040662		A	8	5	40	61	66	M 8 x 34	50
FBN II 8/10 (8x71)	040664		B	8	10	40	66	71	M 8 x 39	50
FBN II 8/20 (8x81)	040669		D	8	20	40	76	81	M 8 x 49	50
FBN II 8/30 (8x91)	040700		F	8	30	40	86	91	M 8 x 59	50
FBN II 8/50 (8x111)	040771		K	8	50	40	106	111	M 8 x 79	50
FBN II 8/70 (8x131)	040777		M	8	70	40	126	131	M 8 x 99	20

Type	Art.-No.	ETA DIBt	Imprint on head	drill d_o [mm]	max. usable length t_{fix} [mm]	anchorage depth h_{ef} [mm]	min. drill-hole depth for through fixings t_d [mm]	anchor length l [mm]	thread [Ø x length]	qty. per box pcs.
FBN II 8/100 (8x161)	040783	■	P	8	100	40	156	161	M 8 x 100	20
FBN II 10/10 (10x86)	040827	■	B	10	10	50	78	86	M 10 x 46	50
FBN II 10/20 (10x96)	040851	■	D	10	20	50	88	96	M 10 x 56	50
FBN II 10/30 (10x106)	040854	■	F	10	30	50	98	106	M 10 x 66	50
FBN II 10/50 (10x126)	040855	■	K	10	50	50	118	126	M 10 x 86	20
FBN II 10/70 (10x146)	040931	■	M	10	70	50	138	146	M 10 x 100	20
FBN II 10/100 (10x176)	040943	■	P	10	100	50	168	176	M 10 x 100	20
FBN II 10/140 (10x216)	040944	■	S	10	140	50	208	216	M 10 x 100	20
FBN II 10/160 (10x236)	040945	■	T	10	160	50	228	236	M 10 x 100	20
FBN II 12/10 (12x106)	040950	■	B	12	10	65	95	106	M 12 x 59	20
FBN II 12/20 (12x116)	044558	■	D	12	20	65	105	116	M 12 x 69	20
FBN II 12/30 (12x126)	045263	■	F	12	30	65	115	126	M 12 x 79	20
FBN II 12/50 (12x146)	045264	■	K	12	50	65	135	146	M 12 x 99	20
FBN II 12/80 (12x176)	045265	■	N	12	80	65	165	176	M 12 x 129	20
FBN II 12/100 (12x196)	045266	■	P	12	100	65	185	196	M 12 x 149	20
FBN II 12/120 (12x216)	045267	■	R	12	120	65	205	216	M 12 x 169	20
FBN II 12/140 (12x236)	045268	■	S	12	140	65	225	236	M 12 x 189	20
FBN II 12/160 (12x256)	045269	■	T	12	160	65	245	256	M 12 x 100	20
FBN II 16/25 (16x145)	045564	■	E	16	25	80	129	145	M 16 x 89	10
FBN II 16/50 (16x170)	045565	■	K	16	50	80	154	170	M 16 x 114	10
FBN II 16/80 (16x200)	045566	■	N	16	80	80	184	200	M 16 x 144	10
FBN II 16/100 (16x220)	045567	■	P	16	100	80	204	220	M 16 x 164	10
FBN II 16/140 (16x260)	045568	■	S	16	140	80	244	260	M 16 x 100	10
FBN II 16/160 (16x280)	045569	■	T	16	160	80	264	280	M 16 x 100	10
FBN II 16/200 (16x320)	045570	■	V	16	200	80	304	320	M 16 x 100	10
FBN II 20/30 (20x184)	045573	■	F	20	30	105	165	184	M 20 x 90	10
FBN II 20/60 (20x214)	045574	■	L	20	60	105	195	214	M 20 x 90	10
FBN II 20/80 (20x234)	045575	■	M	20	80	105	215	234	M 20 x 90	10
FBN II 20/120 (20x274)	045576	■	R	20	120	105	255	274	M 20 x 90	10
FBN II 8/5 K (8x56)	040806	■	-A-	8	5	30	51	56	M 8 x 24	50

Type	Art.-No.	 ETA  DIBt	Imprint on head	drill d_o [mm]	max. usable length t_{fix} [mm]	anchorage depth h_{ef} [mm]	min. drill-hole depth for through fixings t_d [mm]	anchor length l [mm]	thread [Ø x length]	qty. per box pcs.
FBN II 8/10 K (8x81)	040807		-B-	8	10	30	56	61	M 8 x 29	50
FBN II 8/30 K (8x81)	040826		-F-	8	30	30	76	81	M 8 x 49	50
FBN II 10/5 K (10x71)	040946		-A-	10	5	40	63	71	M 10 x 31	50
FBN II 10/10 K (10x76)	040947		-B-	10	10	40	68	76	M 10 x 36	50
FBN II 10/30 K (10x96)	040948		-F-	10	30	40	88	96	M 10 x 56	50
FBN II 12/5 K (12x86)	045272		-A-	12	5	50	75	86	M 12 x 39	20
FBN II 12/10 K (12x91)	045273		-B-	12	10	50	80	91	M 12 x 44	20
FBN II 12/30 K (12x111)	045274		-F-	12	30	50	100	111	M 12 x 64	20
FBN II 16/15 K (16x120)	045571		-C-	16	15	65	104	120	M 16 x 64	10
FBN II 16/25 K (16x130)	045572		-E-	16	25	65	114	130	M 16 x 74	10
FBN II 20/10 K (20x139)	045577		-B-	20	10	80	120	139	M 20 x 50	10
FBN II 12/80 GS (12x176)	045578		N	12	80	65	165	176	M 12 x 129	20
FBN II 12/100 GS (12x196)	045579		P	12	100	65	185	196	M 12 x 149	20
FBN II 12/120 GS (12x216)	045580		R	12	120	65	205	216	M 12 x 169	20
FBN II 12/140 GS (12x236)	045581		S	12	140	65	225	236	M 12 x 189	10
FBN II 12/160 GS (12x256)	045583		T	12	160	65	245	256	M 12 x 100	10
FBN II 12/180 GS (12x276)	045584		U	12	180	65	265	276	M 12 x 100	10
FBN II 12/200 GS (12x296)	045585		V	12	200	65	285	296	M 12 x 100	10
FBN II 12/250 GS (12x346)	045586		W	12	250	65	335	346	M 12 x 100	10
FBN II 16/80 GS (16x200)	045587		N	16	80	80	184	200	M 16 x 144	10
FBN II 16/100 GS (16x220)	045588		P	16	100	80	204	220	M 16 x 164	10
FBN II 16/120 GS (16x240)	045589		R	16	120	80	224	240	M 16 x 184	10
FBN II 16/140 GS (16x160)	045590		S	16	140	80	244	260	M 16 x 100	10
FBN II 16/160 GS (16x280)	045591		T	16	160	80	264	280	M 16 x 100	10
FBN II 16/180 GS (16x300)	045592		U	16	180	80	284	300	M 16 x 100	10
FBN II 16/200 GS (16x320)	045593		V	16	200	80	304	320	M 16 x 100	10
FBN II 16/250 GS	052192		W	16	250	80	354	370	M 16 x 100	10
FBN II 16/300 GS	052204		X	16	300	80	404	420	M 16 x 100	10